

# FF109-250

1 Hour Fire Rated Downlight Cover  
Suitable for low profile LED lights up to 6"

---

## Product Description

The FF109-250 is a cone-shaped intumescent enclosure which has been specifically designed to help protect openings for 6" low profile LED downlight fixtures.

The ultra-flexible nature of the material allows the cover to get rolled up for easy retrofit, remodel or new construction installation from below the ceiling and provide a 60 minute flame, smoke and heat barrier.

---

## Key Benefits

- Easy Installation - can be fitted in seconds - no screws, drilling or additional sealant required
  - Can be folded and fitted from above or below the ceiling
  - 60 minute fire protection
  - Flexible material enables the cover to be fitted around obstacles or retro-fitted
  - Enhances the acoustic protection of the ceiling
  - Maintenance free
  - Lightweight
  - The only fire tested solution for retrofit applications
  - Fits most 6" low profile LED downlight fixtures and LED wafer lights
- 

## Approvals

ETL-Intertek certified to maintain the fire rating (1 hour) of fire-resistance rated floor/ceiling assemblies.

## Performance Data

## For Use:

- ETL-Intertek certified to maintain the fire rating (1 hour) of fire-resistance rated floor/ceiling assemblies.
- Tested to ASTM E119
- UBC 71
- NFPA 251
- ASI A2.1



## Dimensions

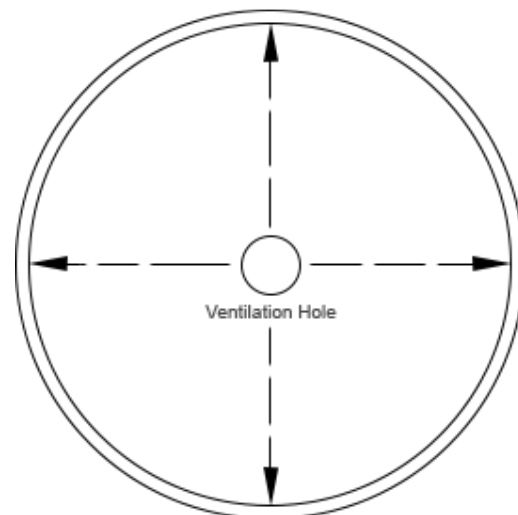
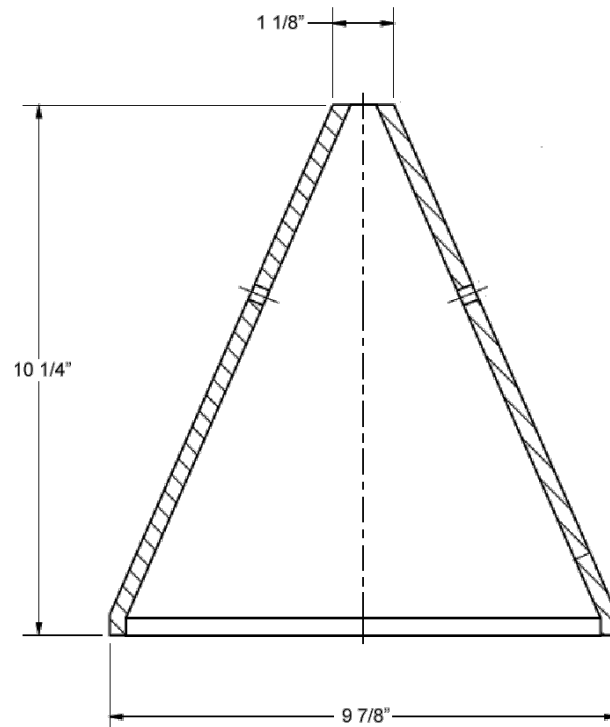

## Installation Steps

\*Install junction box according to manufacturer instructions.

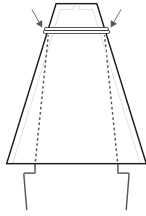

### STEP 1

Ensure the metal wire, which is included with the cover, is inserted through the pre-punched slots located near the top of the cover. Following this action will ensure the coil is secured around the outside of the cone.

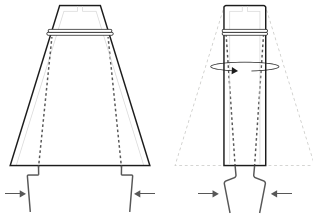

### STEP 2

Grasp the legs of the bronze wire firmly and roll cover into a tight cylinder.

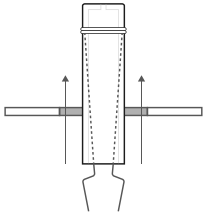

### STEP 3

Keeping a tight grip on the legs, feed the cover through the ceiling cutout.

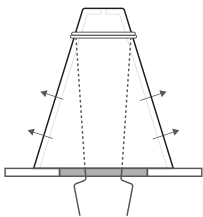

### STEP 4

Ensure the cover has sprung back into its original cone shape before proceeding.

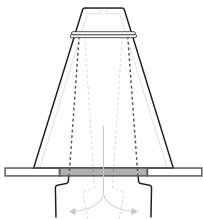

### STEP 5

Grasp legs and pull down until L section clears the underside of the ceiling.

## Installation Steps (Continued)

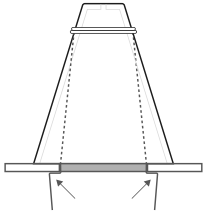
**STEP 6**

Move legs out until vertical part of L section is flush with the side of the cut out. Release the legs so they grip the underside of the ceiling.

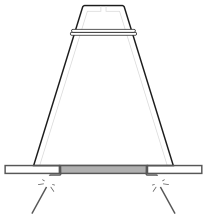
**STEP 7**

Remove the excess of both legs.

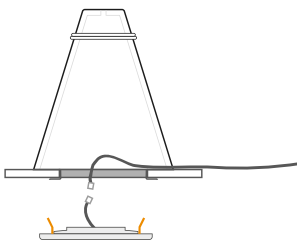
**STEP 8**

Once the cover is in place, the LED light element can be fitted following the light manufacturer's instructions.

## Safety Considerations

\*Be sure the electricity to the system you are working on is turned off; either the fuse removed or the circuit breaker set at off.

### *CONTAINS STONE WOOL INSULATION*

Stone fibers may cause temporary mechanical irritation to the skin, throat, nose and eyes.

### *FIRST AID*

#### **Skin**

If irritation occurs, do not rub or scratch. Rinse under running water prior to washing with mild soap and water. Consult a physician if irritation persists.

#### **Throat and Eyes**

If irritation occurs, flush eyes with water and/or drink water to clear throat. Do not rub the eyes. Consult a physician if irritation persists.

### *PRECAUTIONS*

Wear long sleeve, loose fitting clothing, gloves and eye protection. For additional information, refer to the Material Safety Data Sheet.

Notes

A series of horizontal dotted lines for taking notes.

# FF109-250

---

Vanco International, LLC  
506 Kingsland Dr.  
Batavia, IL 60119 USA



(630) 879-0006  
[www.vanco1.com](http://www.vanco1.com)



Tenmat warrants the materials it produces will conform to Tenmat specifications and approved drawings where applicable. It is entirely the customer's responsibility to make the final product choice and satisfy themselves of the suitability of the product for the intended application, carrying out testing where required. For construction projects, all products which the customer is intending to use on a particular project must be approved in writing by the customer's building designer, system designer or design control professional, to ensure compliance with the latest regulations.

The information contained in Tenmat data sheets is presented in good faith. Tenmat Limited makes passive fire protection product suggestions based solely upon and limited to the information made available to Tenmat. Tenmat possesses knowledge of fire test data and offers manufacturers installation advice. Within reason, Tenmat is skilled at offering opinion concerning the installations in question, and can comment on interfaces with other construction materials, but this is not a recommendation or decision. Decisions on overall building fire strategy are not made by Tenmat. Tenmat products have been tested for a wide range of construction types, and they must be only used in accordance with Tenmat test evidence. Each specific Tenmat product must be installed into a construction that matches the corresponding test report. Tenmat product performance requires safe and proper handling and correct installation. For construction projects, all products which the customer is intending to use on a particular project must be approved in writing by the customer's building designer, system designer or design control professional, to ensure compliance with the latest regulations. Tenmat can provide the relevant fire test evidence on request.